



IS Full Kit

This kit can be used to perform implant surgery for IS-II active, IS-II, IS (Ø3.5~Ø5.0). For S-Wide(diameter Ø5.5~Ø7.0) implant surgery, S-Wide Kit additionally required



Product name	ISFKIT
--------------	--------

• Drill Length Guide

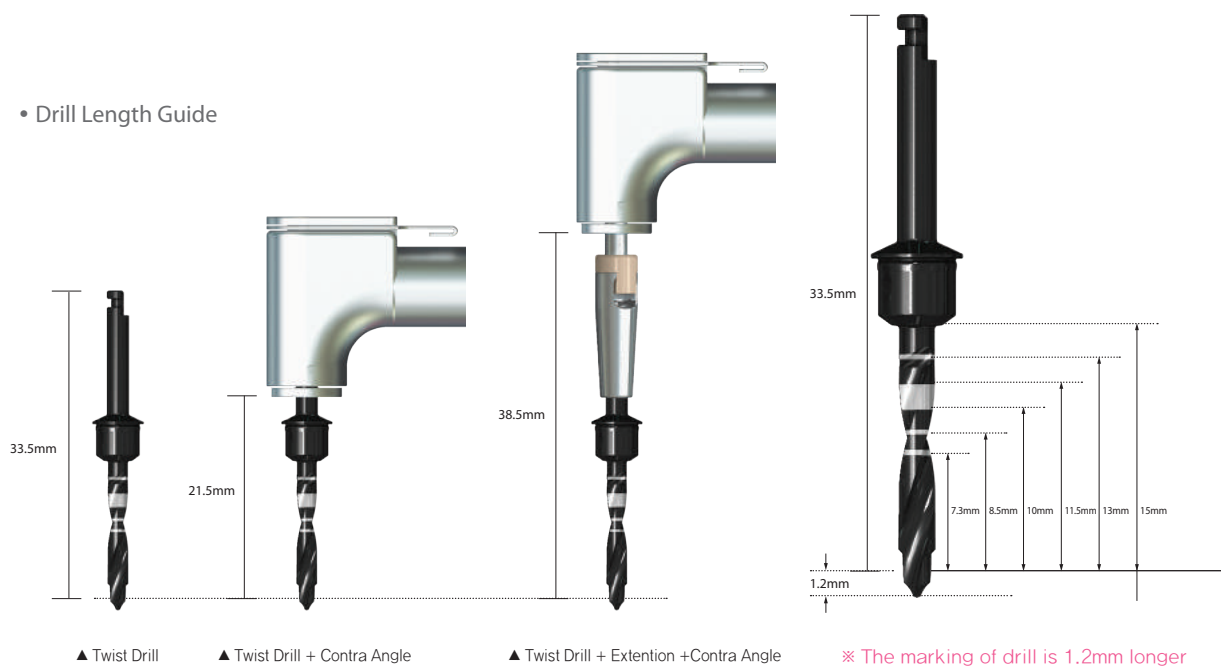

Dental Implant system

IS Full Kit Components

• Point Lindemann Drill

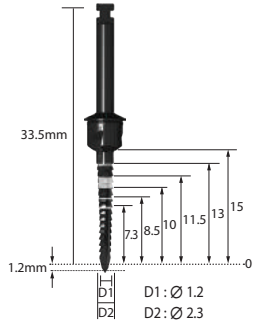

Diameter	Product name
Ø2.3	LDS23C

• Initial Drill

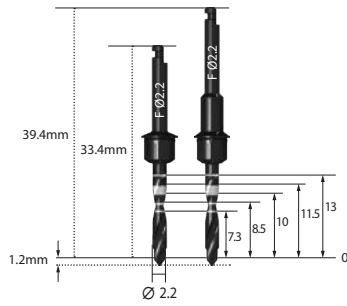

Diameter	Type	Product name
Ø2.2	Short	TSD22CS
Ø2.2	Long	TSD22CL

• Twist Drill

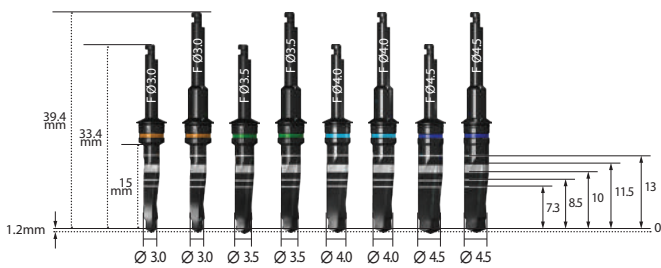

Diameter	Type	Product name
Ø3.0	Short	TSD30CS
Ø3.0	Long	TSD30CL
Ø3.5	Short	TSD35CS
Ø3.5	Long	TSD35CL
Ø4.0	Short	TSD40CS
Ø4.0	Long	TSD40CL
Ø4.5	Short	TSD45CS
Ø4.5	Long	TSD45CL

• Stopper

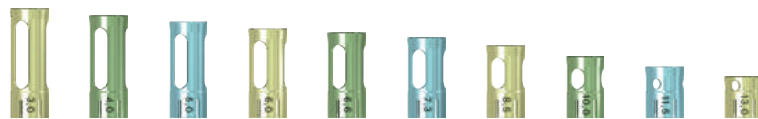

Stopper	3.0	4.0	5.0	6.0	6.6	7.0	8.5	10.0	11.5	13
Drilling Length(mm)	4.2	5.2	6.2	7.2	7.8	8.5	9.7	11.2	12.7	14.2
Product name	DS030C	DS040C	DS050C	DS060C	DS066C	DS070C	DS085C	DS100C	DS115C	DS130C

* Stoppers cannot be connected to Ø4.9 Twist Drill(TSD49F) only



Dental Implant system



IS Full Kit Components

• Cortical Drill

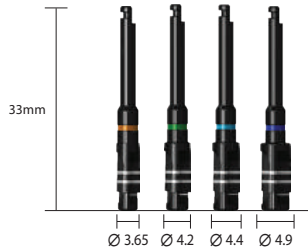

Diameter	Product name
Ø3.65	ISCD35F
Ø4.2	ISCD40F
Ø4.4	ISCD45F
Ø4.9	ISCD50F

• Cortical Tap

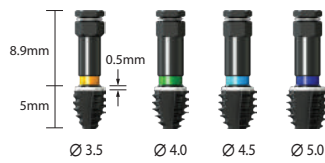

Diameter	Product name
Ø3.5	PTAP35FS
Ø4.0	PTAP40FS
Ø4.5	PTAP45FS
Ø5.0	PTAP50FS

• IS Fixture Driver

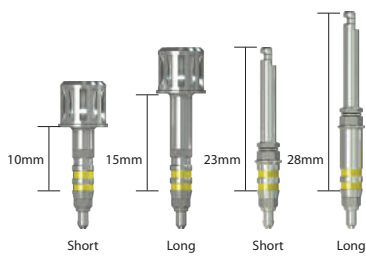

Length	Product name
Ratchet (Short)	ISFD10R
Ratchet (Long)	ISFD15R
Contra Angle (Short)	ISFD05C
Contra Angle (Long)	ISFD05CL

• Connector

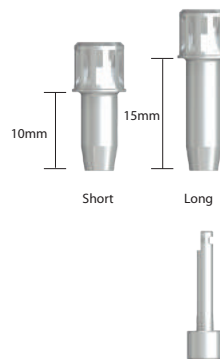

Ratchet

Length	Product name
Short	RC10
Long	RC15

Contra Angle

Product name	CAA00
--------------	-------

• Direction Pin



Diameter	Product name
Ø 3.5	DPIS35C
Ø 4.5	DPIS45C

• Parallel Pin

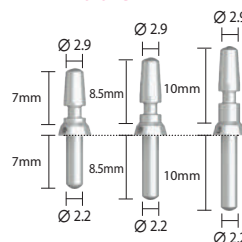

Length	Product name
7.0 mm	PP07F
8.5 mm	PP08F
10.0 mm	PP10F

Dental Implant System



IS Full Kit Components

• Hex Driver

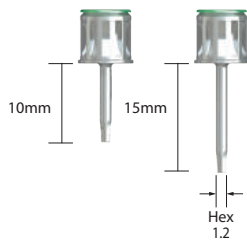

Length	Product name
10mm	HD1210S
15mm	HD1215S

• Drill Extension



Product name	DE01
--------------	------

• Torque Ratchet



Product name	TW60
--------------	------

• Driver Holder

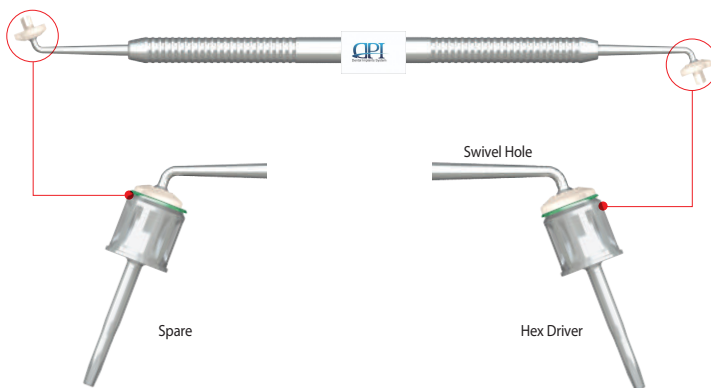

Product name	DH01
--------------	------

• Depth gauge



Product name	DG17
--------------	------



IS Full Kit - IS-II active, IS-II Drilling Sequence

Drilling Speed & Torque

- Point Lindemann, Initial Drill, Twist Drill : 1,200rpm / 35~45Ncm
- Cortical Tap / Profile Tap : 50rpm / 50Ncm
- Cortical Drill : 1,200rpm / 35~45Ncm (Conventional Loading case)

• IS-II active Fixture $\varnothing 3.5$ X 10mm (D1/D2 bone)

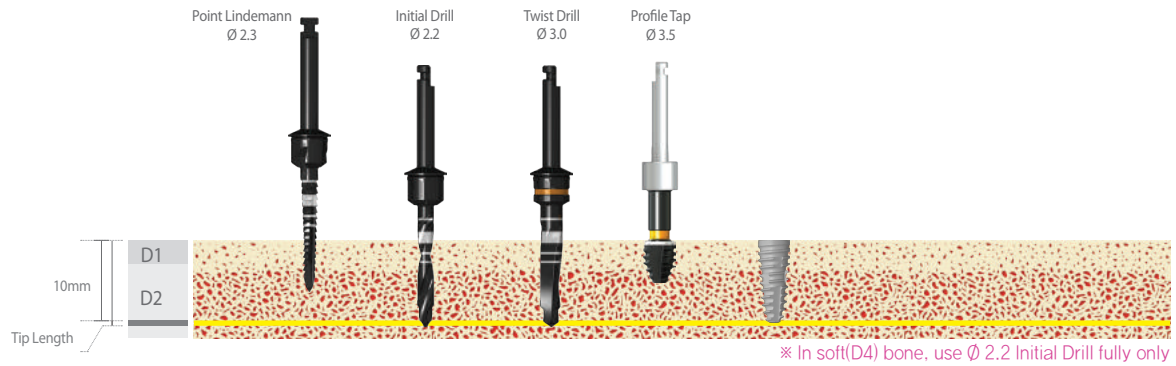

• IS-II active Fixture $\varnothing 4.0$ X 10mm (D1/D2 bone)

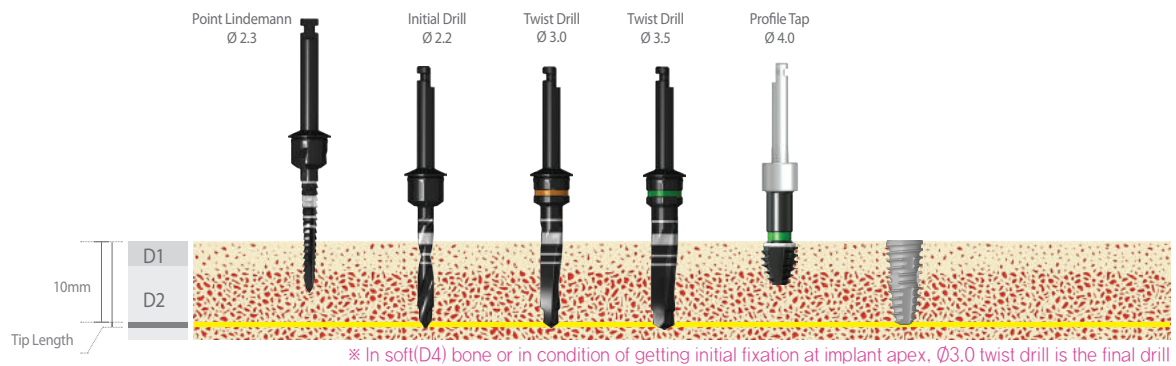

• IS-II active Fixture $\varnothing 4.5$ X 10mm (D1/D2 bone)

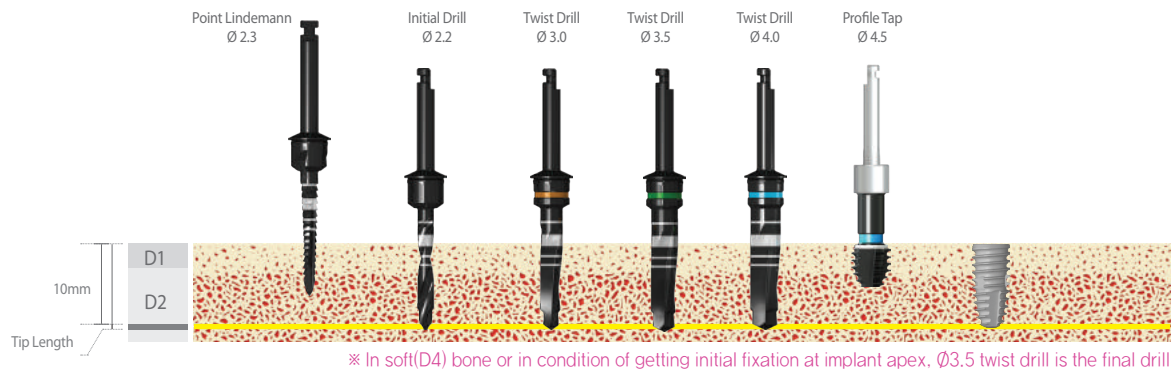

• IS-II active Fixture $\varnothing 5.0$ X 10mm (D1/D2 bone)

